

Article number: 20193B32B32602SW
 Description: E+G T-angel clamp
 GN 193-B32-B32-60-2-SW

Measures

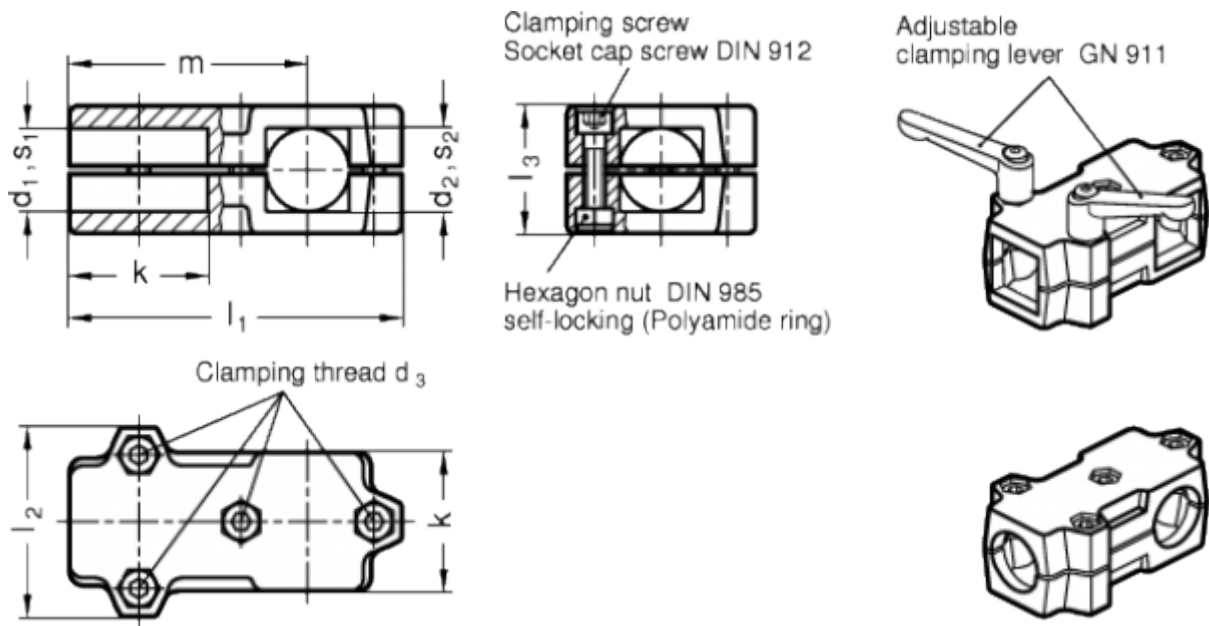

Accessories = GN 911-M8-55	m	= -
d1 = 32	s1	= -
d2 = 32	s2	= -
d3 = M8	Weight in (g) = 730	
k = 60		
l1 = 141		
l2 = 79		
l3 = 59		